

to \$3,000 fine for employing on trains men known to be dangerous on account of their drinking habits, and any person working in the train service and being intoxicated is liable to imprisonment for one year.

Lobbyists.—Nebraska has a law requiring legislative agents to be registered and to report their expenses.

Mercantile Business.—The new constitution of Oklahoma, not yet in effect, has a clause, like that in the Federal statute, forbidding railroads to transport their own products or manufactures except for their own use.

Penalties for Appealing.—Three states, Alabama, Arkansas and Missouri, have enacted laws designed to punish any railroad company which by appeal, or by any process, transfers to a Federal court any suit begun in a state court to enforce the laws of the state against the railroad.

Taxation.—In Nebraska a new law affecting local taxes increases the burden on the railroads of the state \$500,000 yearly. In New Mexico there is a new law taxing sleeping cars. In Utah taxation is regulated by a new law, chapter 9.

Telephones.—In Montana railroads are required to allow all telephone companies to put up instruments in stations.

Train Rules.—An Indiana law requires the State Railroad Commission to see that the rules of the operating department of railroads shall be adequate and satisfactory. There is a provision for holding a convention of railroad men annually to consider this subject.

Safety Appliances.—We have made no mention of laws regulating safety devices—air-brakes, automatic couplers, grab irons, etc. Several states have passed laws of this kind, but as all are substantially similar to the Federal law on this subject, and as the practice of nearly or quite all of the railroads in every state now conforms to the Federal law, at least as well as it would conform to a state law, these new state statutes may be treated merely as confirmatory supplements to the Federal law. It is to be noted, however, that there are now three states in which the use of the block system is compulsory, on the order of the State Railroad Commission, namely, Indiana, Massachusetts and Minnesota. In Massachusetts this law has been in effect about a year but we have as yet heard of no mandatory order being issued. The state of Washington has provided for a safety appliance inspector at a salary of \$2,000 a year. He must look after railroad safety generally. He may order dangerous cars out of service. The appointee must have had seven years' experience in railroad operation and must give a bond of \$5,000 for the faithful performance of his duties.

In Nebraska night telegraph operators and towermen must be at least 21 years of age. In Minnesota the state commission must inspect and approve new railroads before they are put in use. The commission may require interlocking signals not only at crossings of one road with another, but also at junctions and drawbridges. In Illinois the law regulating the establishment of crossings has been revised.

Mallet Compound Locomotive for the Erie Railroad.

The Mallet compound locomotive, introduced to American railroads three years ago in the monster that was built for the Baltimore & Ohio by the American Locomotive Company, has been so efficient from the start, both in economy of operation and maintenance, that its construction was followed closely in the engines of the same general type for the Great Northern illustrated in the *Railroad Gazette* of October 12, 1906; and then came the placing of an order for three of the original general type but of greater capacity for the Erie, to be used in pusher service on the 1.3 per cent. grade between Susquehanna and Gulf Summit, where, with a consolidation locomotive ahead, they will be capable of handling 2,660 tons. Although these Erie engines are much heavier and more powerful than the Baltimore & Ohio engine, the essential features of the two designs—such as flexible joints to high and low-pressure cylinders, receiver and exhaust pipes, articulated connection between frames, boiler, bearings, power reversing gear, etc., are practically the same, none of these features having failed to give perfect satisfaction during the two years this engine has been in continuous service.

The accompanying tabular comparison will show the principle differences in the two designs:

	Baltimore & Ohio.	Erie.
Wheels	0-6-0	0-S-S-0
Total weight	334,500 lbs.	
Size of cylinders	20 & 32 x 32 in.	25 & 39 x 28 in.
Diameter of drivers	56 in.	51 in.
Tractive effort (working simple)	71,500 lbs.	94,800 lbs.
Steam pressure	235 "	215 "
Total wheel base	30 ft. 8 in.	39 ft. 2 in.
Driving wheel base, rigid	10 ft.	
Total heating surface	5,600 sq. ft.	5,313.7 sq. ft.
Grate area	72.2 "	100.0 "
Weight on drivers, tractive effort	4.78	
Total weight, total heating surface	599	
Trac. eff. x diam. drivers, total htg surf.	700	910
Htg. surf., vol. equiv. simple cylinders	295	217
Grate area, vol. equiv. simple cylinders	385	408

It must be noticed in comparing the above ratios that the engine illustrated is provided with a 4-ft. combustion chamber which decreases the total amount of heating surface; a point that will

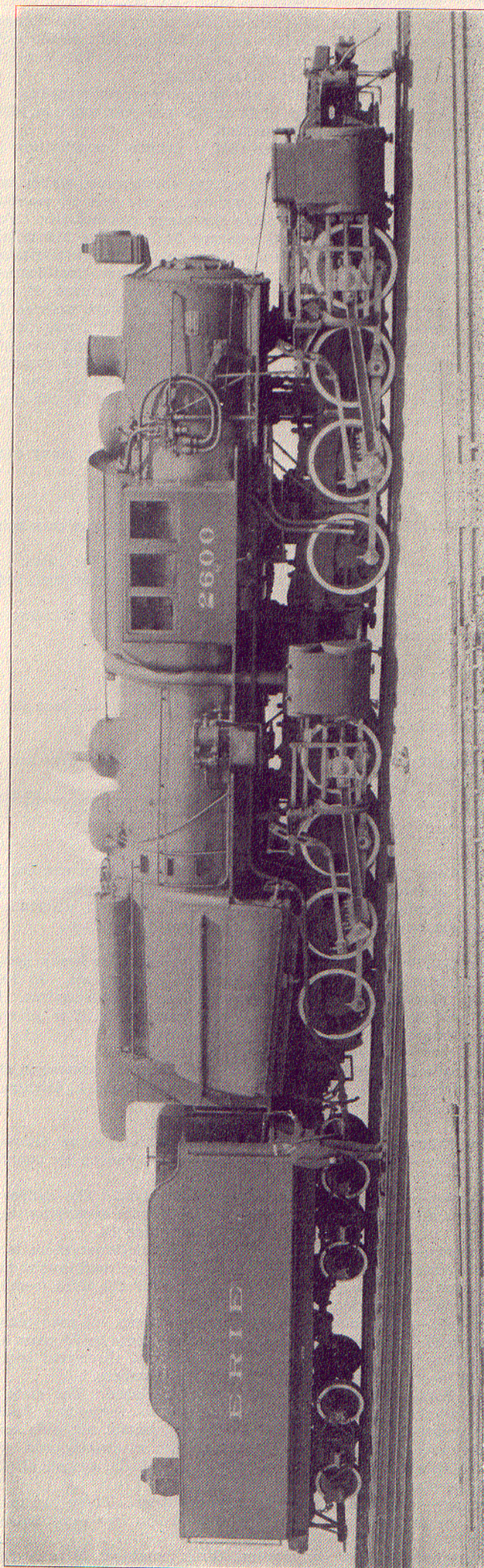

Sixteen-Wheel Mallet Compound Locomotive; Built by the American Locomotive Company for the Erie Railroad.

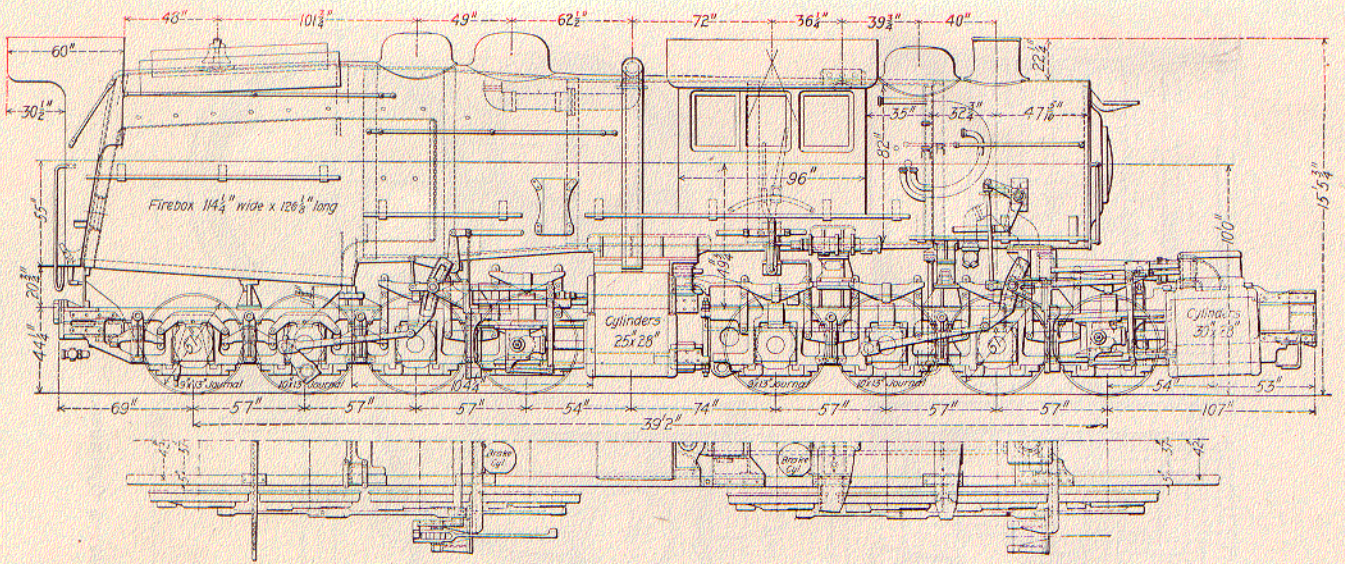

Side Elevation and Half Plan of Running Gear; Erie Mallet Compound.

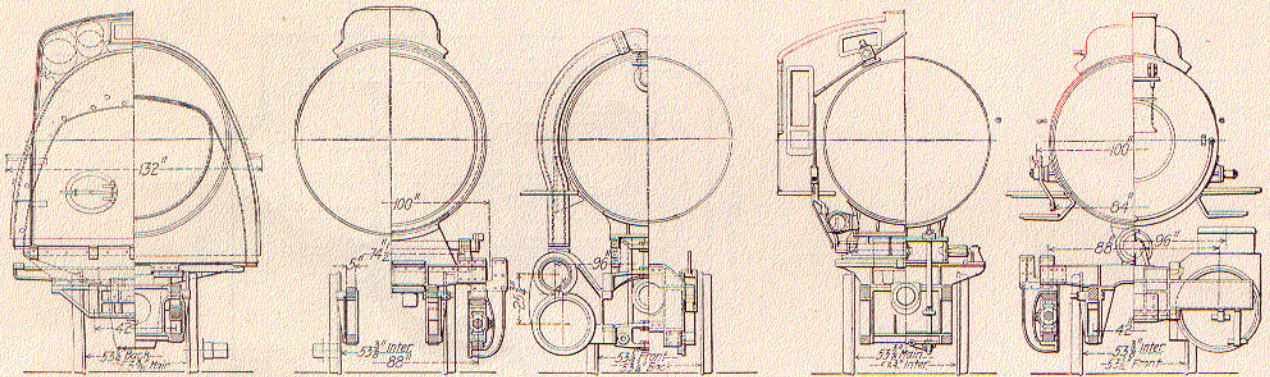

Cross Sections of Erie Mallet Compound.

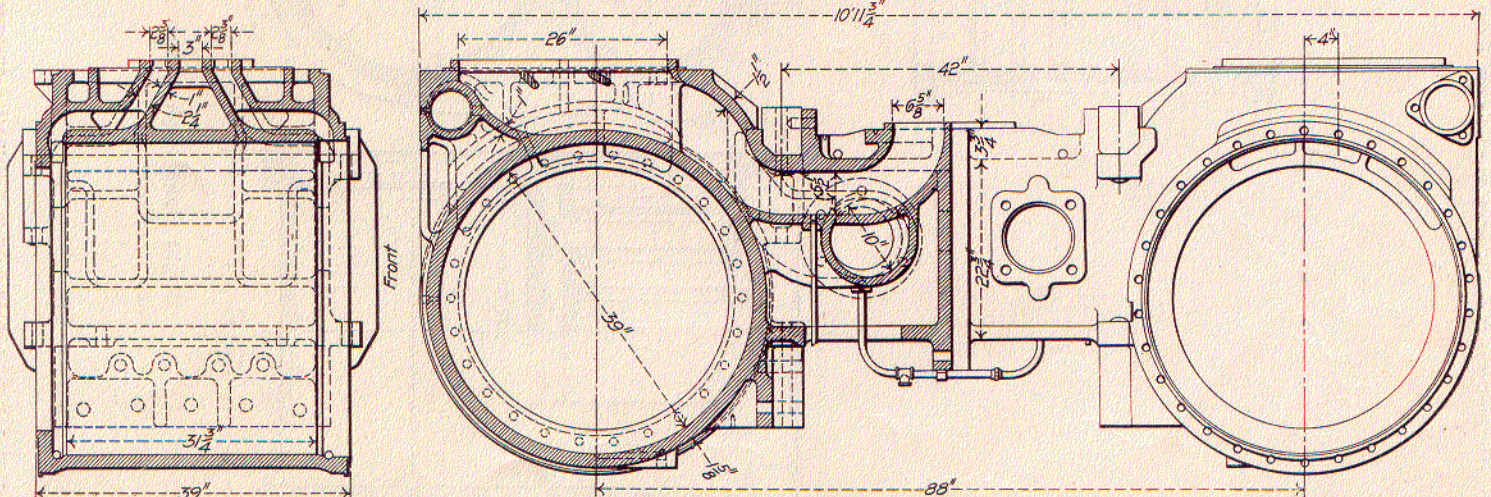
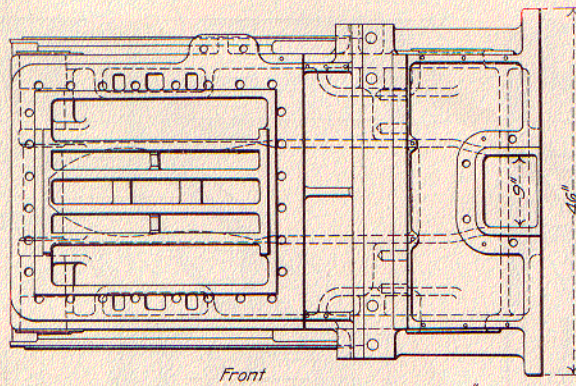

Details of Low Pressure Cylinders; Erie Mallet Compound.

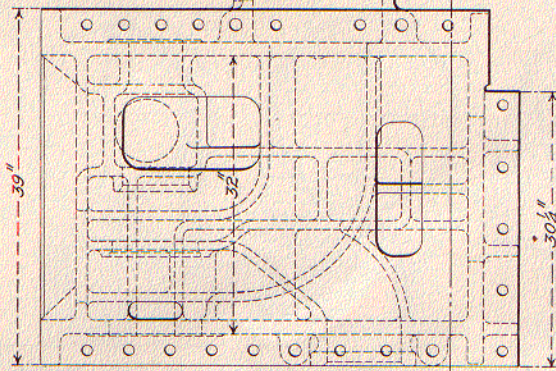
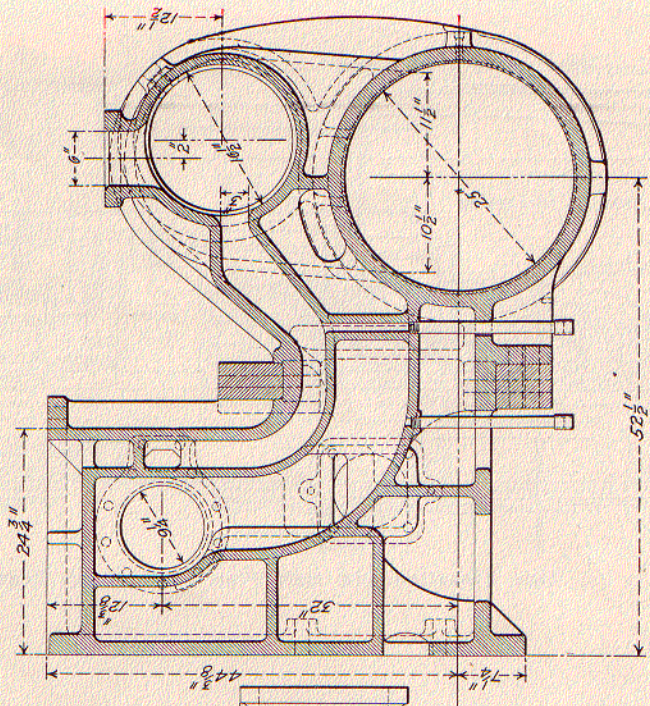
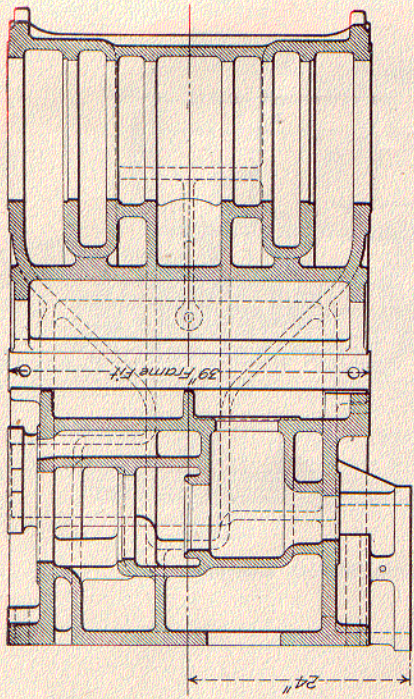

Left Hand High Pressure Cylinder.

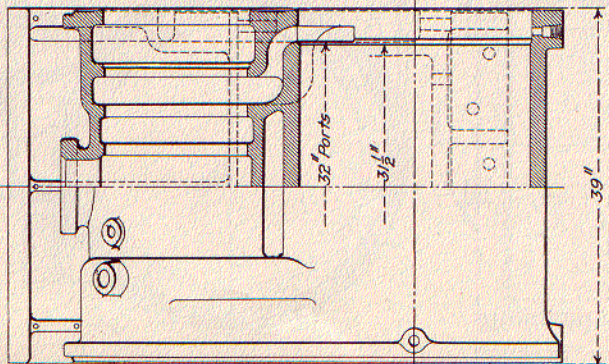
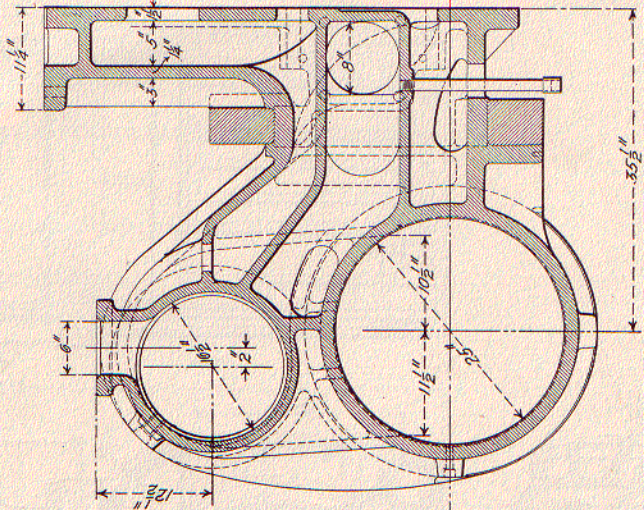
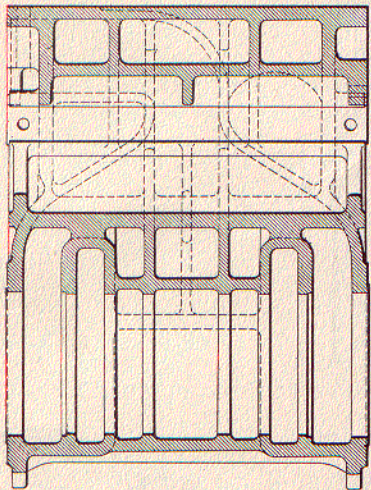

Right Hand High Pressure Cylinder.

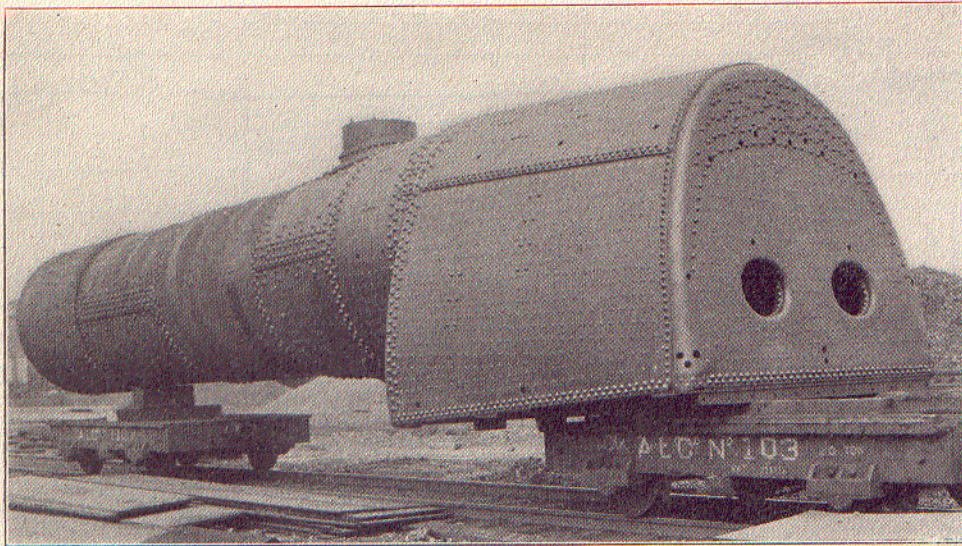

Boiler for Erie Mallet Compound.

of the front tube sheet and is nearer than in any other boiler yet shown in the *Railroad Gazette*. In the construction of the firebox and combustion chamber, sheets $\frac{1}{2}$ in. thick are used for the latter, and the ordinary thickness, $\frac{3}{8}$ in., for the crown and side sheets. The crown sheet drops $5\frac{1}{2}$ in. in its slope from front to back.

The throttle valve is of a peculiar and somewhat novel construction. The great height of the top of the boiler above the rail (14 ft. $7\frac{1}{2}$ in.) necessitates the use of a very low dome, and this in turn makes it advisable to take steam from the top of the same. The throttle valve has therefore been designed with this end in view; and, while it is balanced in the usual manner, steam is taken from the highest and driest part of the dome only. To accomplish this the throttle casing A is surmounted by a crown piece B that curves in and beneath the overhang of the hood C that is fastened to the top of the valve and moves with it. The valve is hollow and is closed at the bottom by a piston $8\frac{11}{16}$ in. in diameter. This piston is furnished with water packing grooves and moves in a cylinder bored in the casing. Steam is admitted at all times to the top and interior of the valve through the space between the crown B and the hood C, a space which is never less than $\frac{1}{4}$ in. This arrangement serves not only to take the steam from near the top of the dome but also acts as a separator. This last feature is due to the fact that it is a tendency of steam under pressure and flowing rapidly over a concave surface, to deposit its contained water under the influence of centrifugal action on that surface. The water so deposited follows along past the upper lip D of the opening to the valve interior and thence down through the central space around the stem to the water in the boiler. Steam is led from the throttle pipe through a short dry pipe to a point directly in line with the high-pressure cylinders, from whence it passes through the top of the shell and is divided in a tee-pipe and passes down through wrought iron steam pipes on either side of the boiler to each of the high-pressure valve chambers. The design of the high-pressure cylinders which is shown in the accompanying illustration is similar to that used on the Baltimore & Ohio engine, the cylinders being cast in pairs with saddles, and the separation between the two cylinders being $8\frac{1}{2}$ in. to the right of the center line of the saddle, to make room for the receiver pipe. The engines are compounded on the Mellin or Richmond system, the intercepting valve being located in the upper part of the left cylinder casting. Exhaust steam from the right high-pressure cylinder passes through a cored passage to the back of the cylinder casting, from whence it passes through an outside U-shaped pipe connecting to a passage in the left cylinder casting leading up into the intercepting valve chamber into which the ex-

haust steam from the left high-pressure cylinder also passes. The emergency exhaust valve is located in the side of the left cylinder casting and has a $4\frac{1}{2}$ -in. jointed pipe connection with an opening in the back of the exhaust pipe in the smokebox. A three-way cock within easy reach of the engineer operates the emergency exhaust valve.

Steam from the high-pressure cylinder passes into a 9-in. receiver pipe extending forward from the center of the cylinder saddle to which it is connected by means of a ball joint. In order to facilitate putting in place or removing, this pipe is made up of three sections and is connected at the front end by means of a slip joint to cover variations in length due to curving to a Y pipe through which steam reaches each of the low-pressure steam chests. The receiver pipe is laid out for 16-deg. curves. The flexible connections are the same as those used in the Baltimore & Ohio design, which have proved so satisfactory—no trouble from leaky joints having been experienced throughout the entire two years this engine has been in service. Steam from the low-pressure cylinders, which are located considerably ahead of the front end of the boiler, exhausts back through a flexible pipe connection to the exhaust pipe in the smokebox. The high-pressure cylinders are equipped with piston valves, and the low-pressure cylinders with Richardson slide valves. The valve gear is, of course, of the Walschaert type. By an ingenious arrangement of the reversing gear the weights of the valve motion of the front and rear engines counterbalance each

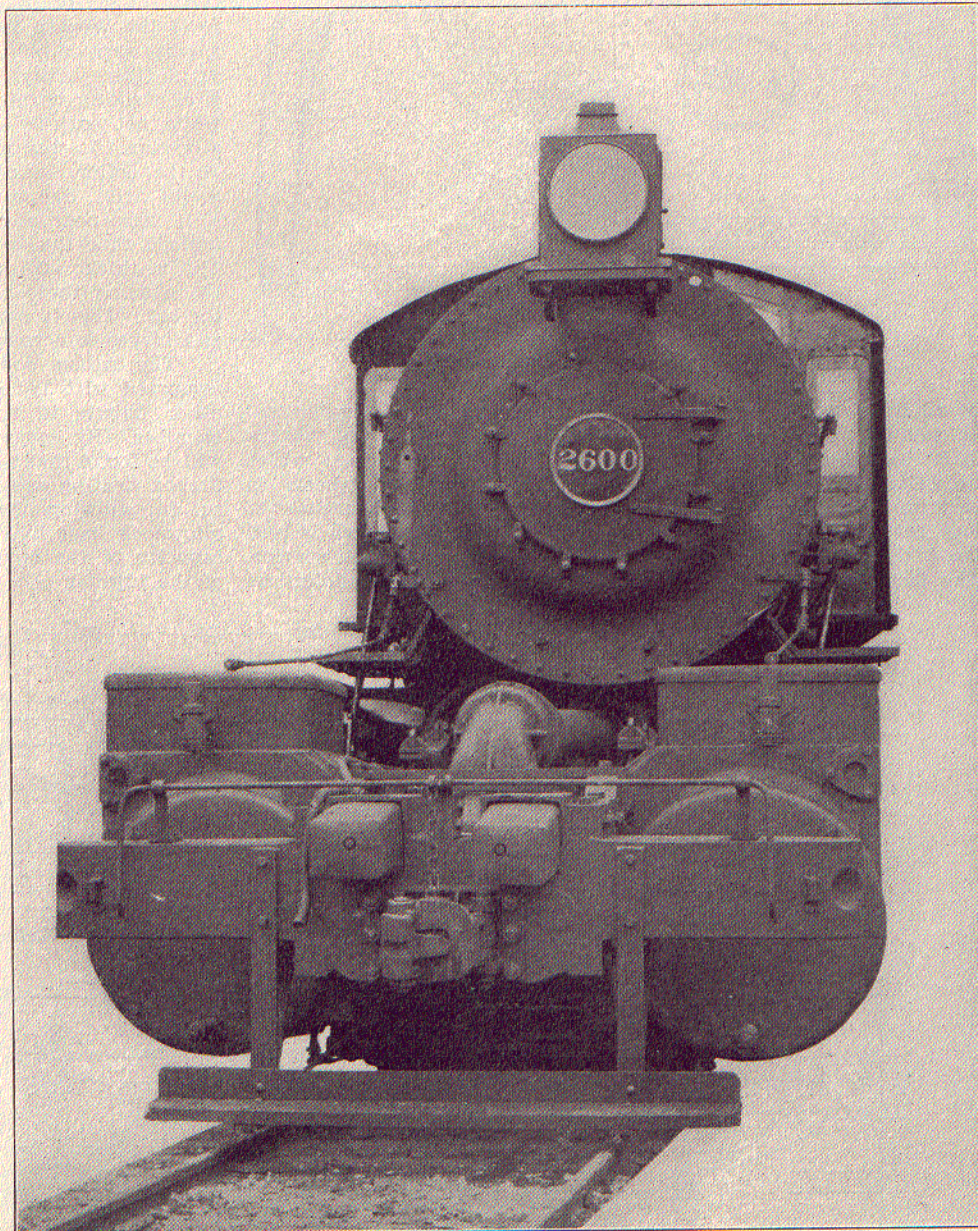

Front View of Erie Mallet Compound Rounding a Curve.

other. The side elevation clearly shows the arrangement. As the high-pressure valves have an internal admission and the low-pressure an external admission it was possible with this arrangement of reversing gear to obtain a most satisfactory valve motion with both eccentric cranks leading the pin, the rear engines taking the forward motion from the top of the link and the front engines from the bottom of the link. The operation of the engine is rendered easier than that of an ordinary road engine by the application of pneumatic reversing cylinders to the ordinary gear with positive automatic locking in any desired position. The frames of both the front and rear engines are of cast steel, 5 in. wide. The articulated connection between the front and rear frames is shown in the illustration of the side elevation.

The part of the weight of the boiler which is carried on the forward engines is supported by a self-adjusting sliding bearing

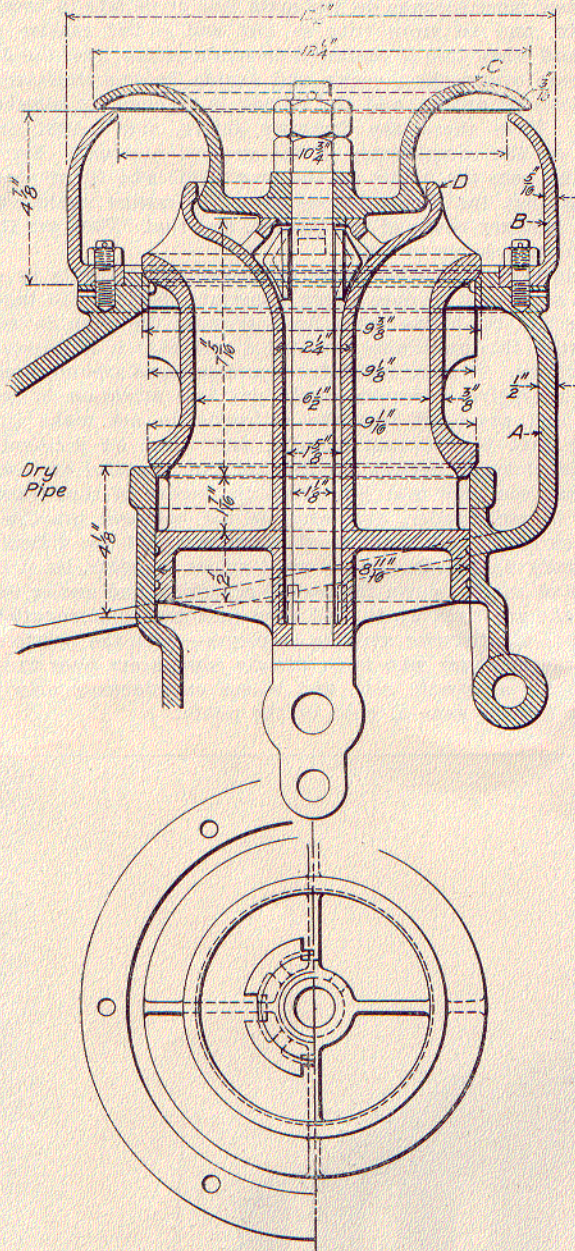

Throttle Valve; Erie Mallet Compound.

located between the third and fourth driving-wheels. This bearing consists briefly of a built-up saddle casting which extends down and bears on a cast steel cross-tie directly below it, through a wrought iron case hardened sliding plate. A brass wearing plate is introduced between the boiler bearing casting and the wrought iron plate. The sliding plate is radially planed on the bottom so that it adjusts itself to the alinement of the engine and the load on the sliding plate is at all times perfectly distributed and there is no cutting of the wearing surfaces. Movement in a vertical direction is prevented by a safety connection between the boiler bearing casting and the cross-tie, which prevents the frames from dropping away from the boiler in case of any derailment. There is also a similar safety connection provided at the front end of the boiler between the guide yoke casting and the exhaust pipe elbow.

Another sliding support is located between the second and third pair of driving wheels. This support is so adjusted that it does not take any of the load except under unusual conditions when

inequalities in the roadbed make it necessary. It is provided with a floating balance device which serves to take some of the load off the main boiler bearing. This device consists of a pair of columns, one on either side of the center of the engine free to sway as the engine turns through curves. These columns have a ball joint connection at the upper ends with saddle castings bolted to the boiler and a ball joint connection at the lower ends with flap castings hinged to the bottom of a cross tie across the lower rails of the frame. Around the outer ends of these hinged castings are U-bolts, the horns of which extend up through the bottom of the cross tie and through coil springs seated on the cross tie. These springs thus exert an upward force on the columns equal to the total compression of the springs. The initial total compression is 30,000 lbs., which can be increased by screwing down the spring caps by means of nuts on the ends of the U-bolts. This boiler support is also provided with a spring centering device of the same design as that used on the Baltimore & Ohio engine.

Another sliding support is formed between the exhaust pipe elbow and the guide yoke casting. As mentioned above this support also forms a connection between the boiler and the frames.

The four pairs of front driving wheels are equalized together on each side and cross equalized in front of the forward drivers, making this system equivalent to a single supporting point. The rear engine on the other hand is equalized throughout on each side only without cross equalization. This forms a complete three point suspended engine, or the best obtainable condition for flexibility and ease on the track.

The following are some of the principal dimensions of the engine:

Cylinder diameter, H. P.	25 in.
Cylinder diameter, L. P.	39 "
Piston stroke	28 "
Wheel base, rigid	14 ft. 3 in.
" " total	39 " 2 "
" " engine and tender	70 " 5 1/2 "
Weight	410,000 lbs.
Heating surface, tubes	4,971.5 sq. ft.
" " firebox	342.2 "
" " total	5,313.7 "
Grate area	100.0 "
Journals, main	10 in. x 13 in.
" trailing	9 " x 13 "
" tender	5 1/2 " x 10 "
Steam pressure	215 lbs.
Firebox, type	Wooten
" length	10 ft. 6 1/2 in.
" width	9 " 6 1/4 "
" thickness, tube sheet	1/2 in.
" thickness side, back and crown sheets	3/8 in.
" water space	5 in.
Tubes, number	404
" diameter	2 1/4 in.
" length	21 ft. 0 in.
" gage	0.125 in.
Smokestack, diameter	18 in.
Smokestack, above rails	15 ft. 5 3/4 in.
Valves, H. P. type	Piston
" L. P. type	Richardson balanced
" travel	5 1/2 in.
" lap, H. P.	1 1/8 "
" lap, L. P.	1 "
" exhaust clearance	1/4 in.
" lead H. and L. P.	3/16 in.
Wheels, diameter, drivers	51 in.
Wheels, diameter, tender	33 "
Tractive effort	94,800 lbs.
Ratio, high to low pressure cylinders	1 to 2.43

Weight on drivers	4.32
Tractive effort	909.87
Tractive effort x diameter of drivers	53.14
Heating surface	6.46*
Grate area	17.84
Firebox heating surface	33.5
Total heating surface	6.31
Weight on drivers	6.31
Heating surface	1.0855 sq. ft.
Volume 2 H. P. cylinders = 15.86 cu. ft.	33.5
Heating surface	6.31
Volume 2 h. p. cylinders	6.31
Grate area	6.31
Volume 2 h. p. cylinders	6.31
Tube heating surface, equated to firebox heating surface (Vaughan formula)	1.0855 sq. ft.
Total equated firebox heating surface	1.4287 "

*In per cent.

Picked Up on the Road.

BY GULF.

I am not what is ordinarily known as a traveling man, though I do move about somewhat, and I am not disposed to draw final conclusions from the experience of one man; still I cannot help wondering whether my experience is exceptional or whether I am a railroad hoodoo. During the past eight or nine months I have moved across a considerable territory in the south, east and north, on many different roads, and I have not yet reached my destination on time. This is a broad statement, but it is rigidly true. The